

Produktinformation

**Flow Transmitter /
Switch OMNI-CF**



- Flow measurement device using the vortex measurement principle
- Analog output 4..20 mA or 0..10 V
- Two programmable switches
- Graphical LCD display, backlit, can be read in sunlight and in the dark
- Selectable units in the display
- Programmable parameters via rotatable, removable ring (programming protection)
- Electronics housing with non-scratch, chemically resistant glass
- Rotatable electronic housing for best reading position
- Designed for industrial use
- Small, compact construction
- Simple installation

Characteristics

A narrow triangular body (1), which goes through the complete cross-section of the measurement pipe, creates vortices in the medium when there is a flow (Kármán vortex street, vortex effect). The frequency of the vortex is proportional to the flow, and is detected using a piezo-sensor (2), which lies behind the triangular body. The complete unit, vortex body, and detector are designed as a plug-in unit (3), and are inserted into the pipe. Here, a lightning fast separation between measurement pipe and the complete measurement unit is possible.

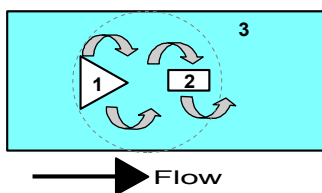

The OMNI transducer located on the sensor has a backlit graphics LCD display which is very easy to read, both in the dark and in bright sunlight. The graphics display allows the presentation of measured values and parameters in a clearly understandable form. The measured values are displayed to 4 places, together with their physical unit, which may also be modified by the user. The electronics have an analog output (4..20 mA or 0..10 V) and two switching outputs, which can be used as limit switches for monitoring minimal or maximal, or as two-point controllers. The switching outputs are designed as push-pull drivers, and can therefore be used both as PNP and NPN outputs. Exceeding limit values is signalled by a red LED which is visible over a long distance, and by a cleartext in the display.

The stainless steel case has a hardened non-scratch mineral glass pane. It is operated by a programming ring fitted with a magnet, so

there is no need to open the operating controls housing, and its leakproofness is permanently ensured.

By turning the ring to right or left, it is simple to modify the parameters (e.g. switching point, hysteresis...). To protect from unintended programming, it can be removed, turned through 180° and replaced, or completely removed, thus acting as a key.



Technical data

Sensor	vortex principle	
Nominal width	DN 8..25	
Process connection	female thread G 1/4..G 1 (others available on request)	
Metering range	0.9..150 l/min for details, see table "Ranges"	
Measurement accuracy	up to 50 % of full scale value: ±1 % of measured value from 50 % of full scale value: ±2 % of measured value	
Pressure resistance	PN 10 bar	
Medium temperature	0..+60 °C	
Ambient temperature	-20..+70 °C	
Materials medium-contact	Housing	CW614N plated, 1.4571 or POM GF
	Connection	CW614N plated, 1.4571 or POM
	Detector	ETFE PA6T6I 40 % GF
	Seal	EPDM
Materials non-medium-contact	Electronics housing	stainless steel 1.4305
	Glass	mineral glass, hardened
	Magnet	samarium-Cobalt
	Ring	POM
Supply voltage	18..30 V DC	
Power consumption	< 1 W	
Analog output	4..20 mA / max. load 500 Ω or 0..10 V / min. load 1 kΩ	
Switching outputs	transistor output "push-pull" (resistant to short circuits and polarity reversal) I _{out} = 100 mA max.	
Hysteresis	adjustable, position of the hysteresis depends on minimum or maximum	
Display	backlit graphical LCD-Display (transreflective), extended temperature range -20..+70 °C, 32 x 16 pixels, background illumination, displays value and unit, flashing LED signal lamp with simultaneous message on the display.	
Electrical connection	for round plug connector M12x1, 5-pole	
Ingress protection	IP 67 (IP 68 when oil-filled)	
Weight	see table "Dimensions"	
Conformity	CE	

Produktinformation

Signal output curves

Value x = Begin of the specified range
 = not specified range

Current output

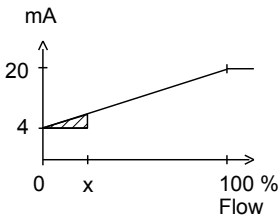

Voltage output

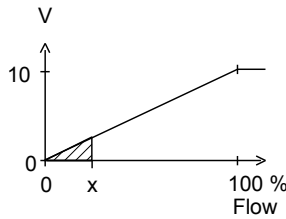

Other characters on request.

Ranges

G	Types	Range l/min H ₂ O
G 1/4	OMNI-CF-008	0.9.. 15 l/min
G 3/8	OMNI-CF-010	1.8.. 32 l/min
G 1/2	OMNI-CF-015	3.5.. 50 l/min
G 3/4	OMNI-CF-020	5.0.. 85 l/min
G 1	OMNI-CF-025	9.0..150 l/min

Wiring

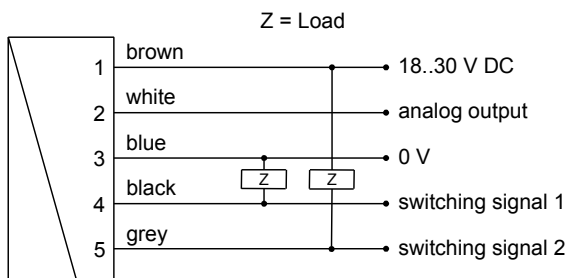

Connection example: PNP NPN

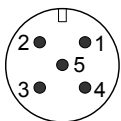

connector M12x1

Before the electrical installation, it must be ensured that the supply voltage corresponds to the data sheet.
 The use of shielded cabling is recommended.

Dimensions

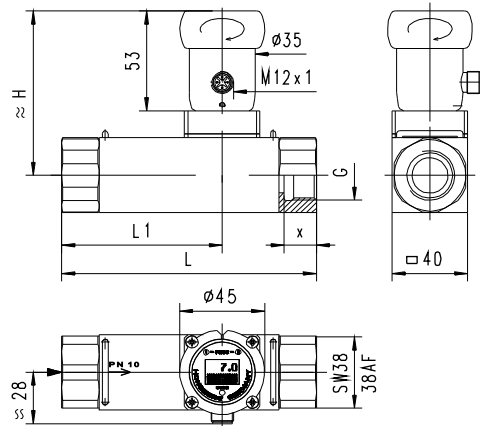

G	DN	Types	H	L	L1	X	Weight* kg
G 1/4	DN 8	OMNI-CF-008	86	125	69	12.5	2.8
G 3/8	DN 10	OMNI-CF-010	84	100	50		2.45
G 1/2	DN 15	OMNI-CF-015	86			14.5	2.45
G 3/4	DN 20	OMNI-CF-020	88	135	85	16.5	2.85
G 1	DN 25	OMNI-CF-025	90	155	95	18.5	2.65

*Weight details for metal model. Plastic models available on request

Gooseneck option



A gooseneck (optional) between the electronics head and the primary sensor provides freedom in the orientation of the sensor. This option simultaneously provides thermal decoupling between the two units. Length of the gooseneck is 140 mm.

Handling and operation

Installation

The vortex flow meter requires a run-in length of 5..10 x D in order to achieve its specified accuracy. If deposits are to be expected, sensor and electronics should not be installed underneath. It should be ensured that the sensor is installed in the direction of the flow arrow. If the sensor is to be cleaned, the clamps should be released, and the device removed (the pipe should be pressure-free for this). It should be ensured during cleaning that the oscillating vortex body is not exposed to impact (in the moulded part there is a sensitive piezo-ceramic sensor, which can break).

Produktinformation

Programming

The annular gap of the programming ring can be turned to positions 1 and 2. The following actions are possible:



Set to 1 = continue (STEP)
Set to 2 = modify (PROG)

Neutral position between 1 and 2

The ring can be removed to act as a key, or turned through 180 ° and replaced to create a programming protector.

Operation is by dialog with the display messages, which makes its use very simple.

Starting from the normal display (present value and unit), if 1 (STEP) is repeatedly selected, then the display shows the following information in this order:

Display of the parameters, using position 1

- Switching value S1 (switching point 1 in the selected unit)
 - Switching characteristic of S1
 MIN = Monitoring of minimum value
 MAX = Monitoring of maximum value
 - Hysteresis 1 (hysteresis value of S1 in the set unit)
 - Switching value S2
 - Switching characteristic of S2
 - Hysteresis 2
 - Code
- After entering the **code 111**, further parameters can be defined:
- Filter (settling time of the display and output)
 - Physical unit (Units)
 - Output: 0..20 mA or 4..20 mA
 - 0/4 mA (measured value corresponding to 0/4 mA)
 - 20 mA (measured value corresponding to 20 mA)

For models with a voltage output, replace 20 mA accordingly with 10 V.

Edit, using position 2

If the currently visible parameter is to be modified:

- Turn the annular gap to position 2, so that a flashing cursor appears which displays the position which can be modified.
- By repeatedly turning to position 2, values are increased; by turning to position 1, the cursor moves to the next digit.
- Leave the parameter by turning to position 1 (until the cursor leaves the row); this accepts the modification
- If there is no action within 30 seconds, the device returns to the normal display range without accepting the modification.

Overload display

Overload of a switching output is detected and indicated on the display ("Check S1 / S2"), and the switching output is switched off.

Simulation mode

To simplify commissioning, the sensor provides a simulation mode for the analog output. It is possible to create a programmable value in the range 0..26.0 mA at the output (without modifying the process variable). This allows the wiring run between the sensor and the downstream electronics to be tested during commissioning. This mode is accessed by means of **Code 311**.

Factory settings

After modifying the configuration parameters, it is possible to reset them to the factory settings at any time using **Code 989**.

The limit switches S1 and S2 can be used to monitor minimal or maximal.

With a minimum-switch, falling below the limit value causes a switchover to the alarm state. Return to the normal state occurs when the limit value plus the set hysteresis is once more exceeded.

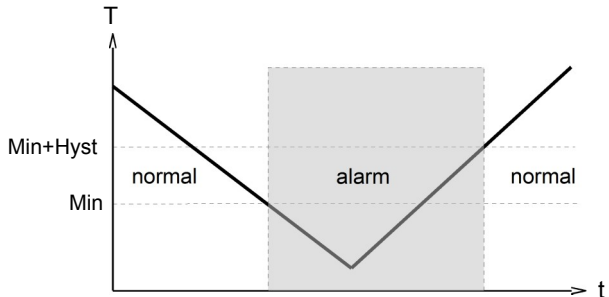

With a maximum-switch, exceeding the limit value causes a switchover to the alarm state. Return to the normal state occurs when the measured value once more falls below the limit value minus the set hysteresis.

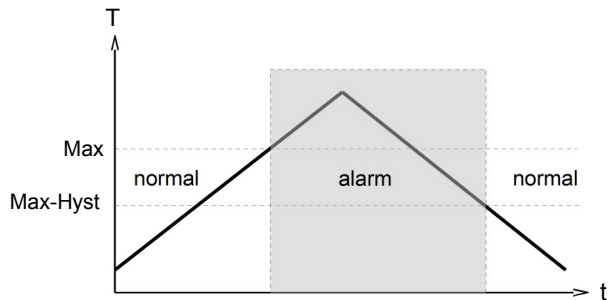

The change to the alarm state is indicated by the integrated red LED and a cleartext in the display.

While in the normal state the switching outputs are at the level of the supply voltage; in the alarm state they are at 0 V, so that a wire break would also display as an alarm state at the signal receiver.

Produktinformation

Ordering code

The basic device is ordered e.g. CF-xxx
with electronics e.g. OMNI-CF-xxx

CF-

OMNI-CF-

○=Option

1. Nominal width							
008	DN 8 - G 1/4						
010	DN 10 - G 3/8						
015	DN 15 - G 1/2						
020	DN 20 - G 3/4						
025	DN 25 - G 1						
2. Process connection							
G	female thread						
3. Connection material							
M	CW614N plated						
K	<input type="radio"/> 1.4571						
P	<input type="radio"/> POM						
4. Body material							
M	CW614N plated						
K	1.4571						
P	<input type="radio"/> POM GF						
5. Metering range							
015	0.9.. 15 l/min						●
032	1.8.. 32 l/min						●
050	3.5.. 50 l/min					●	
085	5.0.. 85 l/min				●		
150	9.0..150 l/min	●					
6. Sealing material							
E	EPDM						
7. Connection for							
E	electronics						
8. For nominal width							
008	DN 8 - G 1/4						●
010	DN 10 - G 3/8						●
015	DN 15 - G 1/2					●	
020	DN 20 - G 3/4				●		
025	DN 25 - G 1	●					
9. Analog output							
I	current output 0/4..20 mA						
U	<input type="radio"/> voltage output 0/2..10 V						
10. Electrical connection							
S	for round plug connector M12x1, 5-pole						
11. Option 1							
H	<input type="radio"/> gooseneck						
O	<input type="radio"/> tropical model <input type="radio"/> oil-filled version for heavy duty or external use						

Accessories

- Cable/round plug connector (KB...) see additional information "Accessories"
- Device configurator ECI-1

... professional Instruments "MADE IN GERMANY"