

Product Information

LABO-CF-S

**Flow Switch
LABO-CF-S**



- Flow measurement device using the vortex measurement principle
- High precision
- High overload protection
- No moving parts
- Rapid installation and removal thanks to clamp fastening
- Various connections using building block system

Characteristics

A narrow triangular body (1), which goes through the complete cross-section of the measurement pipe, creates vortices in the medium when there is a flow (Kármán vortex street, vortex effect). The frequency of the vortex is proportional to the flow, and is detected using a piezo-sensor (2), which lies behind the triangular body. The complete unit, vortex body, and detector are designed as a plug-in unit (3), and are inserted into the pipe. Here, a lightning fast separation between measurement pipe and the complete measurement unit is possible.

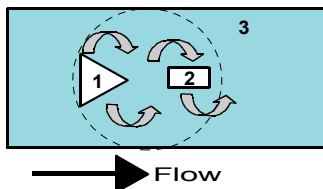

The integrated converter / counter make available an electronic switching output (push-pull) with adjustable characteristics (minimum / maximum) and hysteresis, which responds when an adjustable limit is fallen short of or exceeded.

The switching value can be set to the currently existing flow using "teaching".

Models with analog or pulse output are also available.

Technical data

Sensor	vortex principle
Nominal width	DN 8..25
Process connection	female thread G 1/4..G 1 (others available on request)
Switching ranges	0.9..150 l/min for details, see table "Ranges"
Measurement accuracy	up to 50 % of full scale value: ±1 % of measured value from 50 % of full scale value: ±2 % of measured value
Pressure resistance	PN 10 bar

Medium temperature	0..60 °C	
Ambient temperature	-20..+70 °C	
Materials medium-contact	Housing	CW614N plated, 1.4571 or POM GF
	Connection	CW614N plated, 1.4571 or POM
	Detector	ETFE PA6T6I 40 % GF
	Seal	EPDM
Supply voltage	10..30 V DC	
Power consumption	< 1 W (without load)	
Switching output	transistor output "push-pull" (resistant to short circuits and polarity reversal) I _{out} = 100 mA max.	
Display	yellow LED (On = Normal / Off = Alarm / rapid flashing = Programming)	
Electrical connection	for round plug connector M12x1, 4-pole	
Ingress protection	IP 67 (IP 68 when oil-filled)	
Weight	see table "Dimensions"	
Conformity	CE	

Ranges

G	Types	Range l/min H ₂ O
G 1/4	LABO-CF-008	0.9.. 15 l/min
G 3/8	LABO-CF-010	1.8.. 32 l/min
G 1/2	LABO-CF-015	3.5.. 50 l/min
G 3/4	LABO-CF-020	5.0.. 85 l/min
G 1	LABO-CF-025	9.0..150 l/min

Wiring

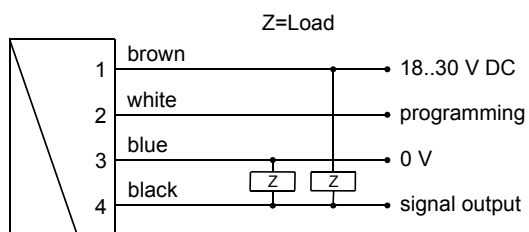

Connection example: PNP NPN

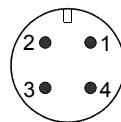

Before the electrical installation, it must be ensured that the supply voltage corresponds with the data sheet. It is recommended to use shielded wiring.

Product Information

LABO-CF-S

Dimensions

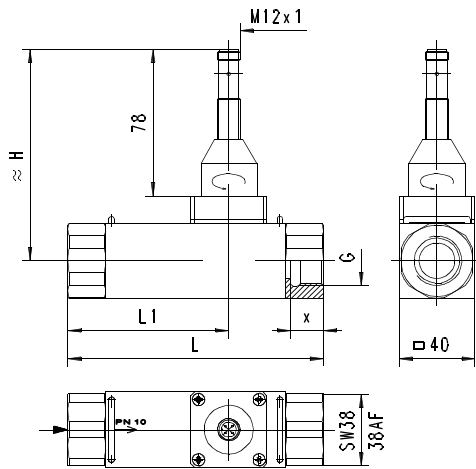

G	DN	Types	H	L	L1	X	Weight* kg
G 1/4	DN 8	LABO-CF-008	111	125	69	12.5	1.62
G 3/8	DN 10	LABO-CF-010	109	100	50		1.27
G 1/2	DN 15	LABO-CF-015	111			14.5	1.27
G 3/4	DN 20	LABO-CF-020	113	135	85	16.5	1.67
G 1	DN 25	LABO-CF-025	115	155	95	18.5	1.47

*Weight details for metal model. Plastic models available on request

Handling and operation

Installation

The vortex flow meter requires a run-in length of 5..10 x D in order to achieve its specified accuracy. If deposits are to be expected, sensor and electronics should not be installed underneath. It should be ensured that the sensor is installed in the direction of the flow arrow. If the sensor is to be cleaned, the clamps should be released, and the device removed (the pipe should be pressure-free for this). It should be ensured during cleaning that the oscillating vortex body is not exposed to impact (in the moulded part there is a sensitive piezo-ceramic sensor, which can break).

Operation and programming

The switching value is set as follows:

- Apply the flow rate to be set to the device.
- Apply an impulse of at least 0.5 seconds and max. 2 seconds duration to pin 2 (e.g. via a bridge to the supply voltage or a pulse from the PLC), in order to accept the measured value.
- When the teaching is complete, pin 2 should be connected to 0 V, so as to prevent unintended programming.

The device has a yellow LED which flashes during the programming pulse. During operation, the LED serves as a status display for the switching output.

To avoid the need to transit to an undesired operating status for the purpose of teaching, the device can be provided ex-works with a teach-offset. The teach-offset point is added to the currently measured value before saving. The offset point can be positive or negative.

Example: The switching value should be set to 80 l/min. However, it is possible only to reach 60 l/min without problems. In this case, the device would be ordered with a teach-offset of +20 l/min. At a flow rate of 60 l/min in the process, teaching would then store a value of 80 l/min.

Note

The switching value can be programmed by the user via "teaching". If desired, programmability can be blocked by the manufacturer. The ECI-1 device configurator with associated software is available as a convenient option for programming all parameters by PC, and for adjustment.

Product Information

LABO-CF-S

The limit switch can be used to monitor minimal or maximal.

With a minimum-switch, falling below the limit value causes a switchover to the alarm state. Return to the normal state occurs when the limit value plus the set hysteresis is once more exceeded.

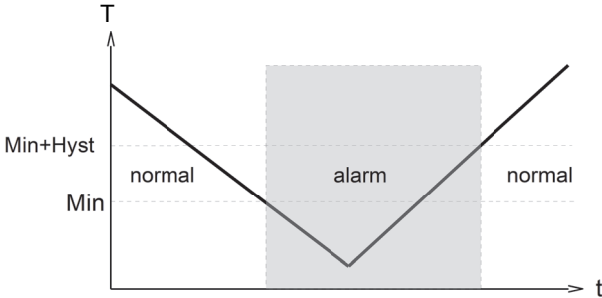

With a maximum-switch, exceeding the limit value causes a switchover to the alarm state. Return to the normal state occurs when the measured value once more falls below the limit value minus the set hysteresis.

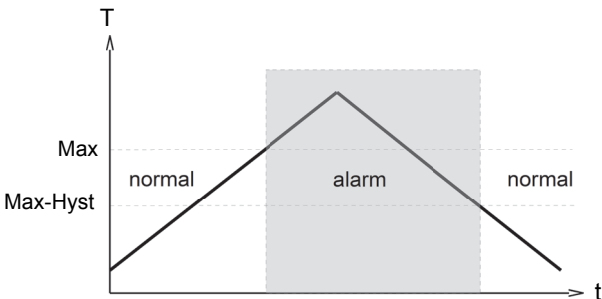

A switchover delay time (t_{DS}) can be applied to the switchover to the alarm state. Equally, one switch-back delay time (t_{DR}) of several can be applied to switching back to the normal state.

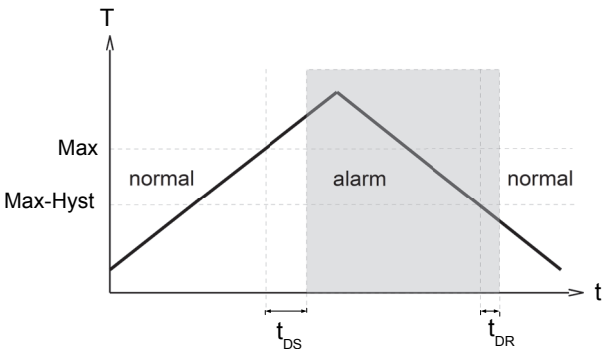

In the normal state the integrated LED is on, in the alarm state it is off, and this corresponds to its status when there is no supply voltage.

In the non-inverted (standard) model, while in the normal state the switching output is at the level of the supply voltage; in the alarm state it is at 0 V, so that a wire break would also display as an alarm state at the signal receiver. Optionally, an inverted switching output can also be provided, i.e. in the normal state the output is at 0 V, and in the alarm state it is at the level of the supply voltage.

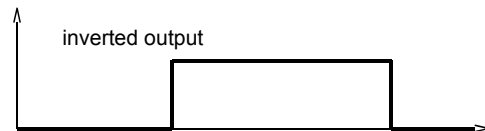
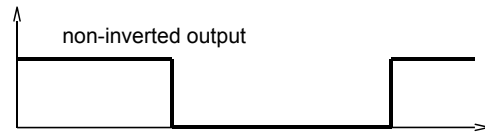

A Power-On delay function (ordered as a separate option) makes it possible to maintain the switching output in the normal state for a defined period after application of the supply voltage.

