

Produktinformation

Flow Transmitter / Switch FLEX-VHZ



- Analog output and switching output
- Designed for industrial use
- Small, compact construction
- Simple installation
- Simple to use
- Cable outlet infinitely rotatable

Characteristics

The VHZ gearwheel flow meter measures the flow on the volumetric principle, in which a pair of gearwheels is moved proportional to the flow rate. The movement of the gearwheels is measured through the enclosing housing wall by a sensor. The devices are suitable for viscous, fluid, self-lubricating media, as well as for aqueous fluids such as soaps, pasts, emulsions etc. which have a non-abrasive character. Because of the volumetric functioning principle, the devices are almost completely independent of viscosity.

The FLEX transducer on the sensor has an analog output (4..20 mA or 0..10 V) and one switching output, which can be configured as a limit switch for monitoring minimal or maximal, or as a frequency output. The switching output is designed as a push-pull driver, and can therefore be used both as a PNP or an NPN output. The state of the switching output is signalled with a yellow LED in the connection; the LED has all-round visibility.

The sensor is configured in the factory, or alternatively this can be done with the aid of the optionally available ECI-1 device configurator (USB interface for PC). A selectable parameter can be modified on the device, with the aid of the magnet clip provided. In this case, the current measured value is saved as the parameter value. Examples of these parameters are the switching value or the metering range end value.

The stainless steel electronics housing is rotatable, so it is possible to orient the cable outlet after installation.

Technical data

Sensor	gearwheel volumeter
Nominal width	DN 8..25
Process connection	G 1/4..G 1
Metering ranges	0.02..150 l/min for details, see table "Ranges"
Measurement accuracy	±3 % of the measured value in the specified metering range (measured at 20 mm ² /s)
Repeatability	±0.3 %
Medium temperature	-25..+80 °C, optionally -25..+120 °C
Ambient temperature	-20..+70 °C
Materials medium-contact	see table "Materials"
Construction material Electronic housing	stainless steel 1.4305 Adapter: CW614N nickelled
Pressure resistance	PN 100..200 bar for details see table "Pressure resistance and weight"
Pressure loss	see upstream page "Function and benefits - volumetric, gearwheel"
Supply voltage	18..30 V DC
Power consumption	<1 W
Analog output	4..20 mA / load 500 Ohm max. or 0..10 V / load min. 1 kOhm
Switching output	transistor output "push-pull" (resistant to short circuits and polarity reversal) I _{out} = 100 mA max.
Switching hysteresis	adjustable (please state when ordering) Standard setting: 2 % of full scale value, for Min-switch, position of the hysteresis above the limit value, and for Max-switch, below the limit value
Display	yellow LED (On = Normal / Off = Alarm)
Electrical connection	for round plug connector M12x1, 4-pole
Ingress protection	IP 65
Weight	see table "Pressure resistance and weight"
Conformity	CE

Produktinformation

Signal output curves

Value x = Begin of the specified range
 = not specified range

Current output

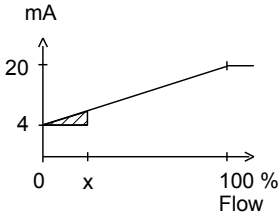

Voltage output

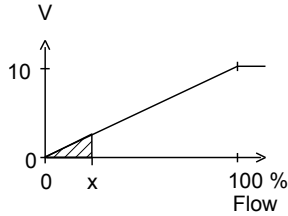

Frequency output

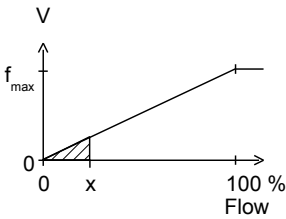

f_{max} selectable in the range of up to 2000 Hz

Other characters on request.

Pressure resistance and weight

G	Types	PN bar	Housing material	Weight kg
G 1/4	FLEX-VHZ-008GA	200	Aluminium	0.65
G 1/4	FLEX-VHZ-008GK	160	Stainless steel	1.65
G 3/8	FLEX-VHZ-010GA	200	Aluminium	0.65
G 3/8	FLEX-VHZ-010GK	200	Stainless steel	1.65
G 3/4	FLEX-VHZ-020GA	200	Aluminium	1.75
G 3/4	FLEX-VHZO-020GA	100	Aluminium / glass	1.75
G 1	FLEX-VHZ-025GA	100	Aluminium	6.50

Ranges

Metering range l/min	Types	Pulse volume (= resolution) cm ³
0.02.. 2	FLEX-VHZ-008	0.04
0.10.. 6	FLEX-VHZ-010	0.20
0.50.. 50	FLEX-VHZ(O)-020	2.00
3.00.. 150	FLEX-VHZ-025	5.22

Materials

	FLEX-VHZ-008..025GA	FLEX-VHZ-008GK	FLEX-VHZ-010..025GK
Housing	Al anodised	stainless steel 1.4404	stainless steel 1.4404
gearwheel and Axis	stainless steel 1.4462	stainless steel 1.4462	stainless steel 1.4462
Bearing	Iglidur X	stainless steel 1.4037 / 1.4016 / PVD-coated	Iglidur X
Seal	FKM	FKM	FKM
Sight glass	glass (only with VHZO)		

Wiring

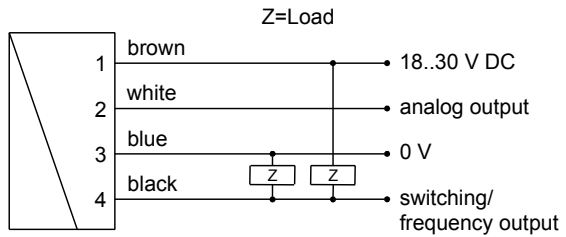

Connection example: PNP NPN

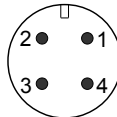

Before the electrical installation, it must be ensured that the supply voltage corresponds with the data sheet. It is recommended to use shielded wiring.

Produktinformation

Dimensions

FLEX-VHZ-008

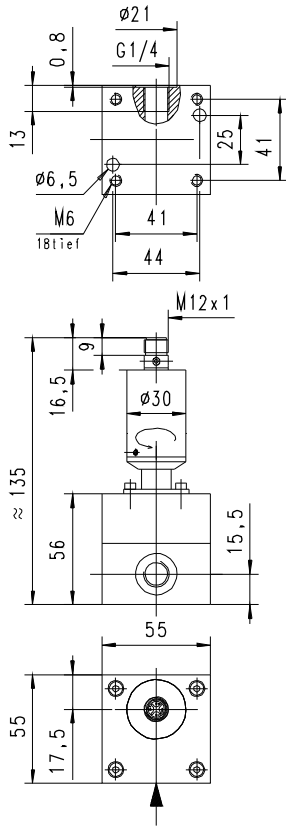

FLEX-VHZ-010

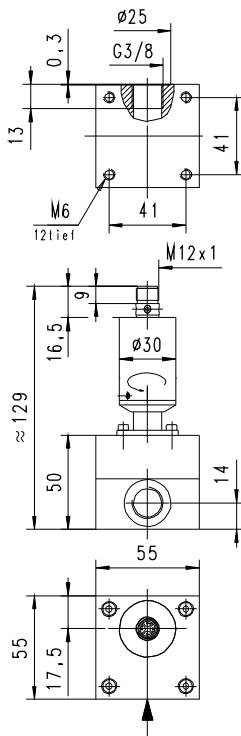

FLEX-VHZ-020

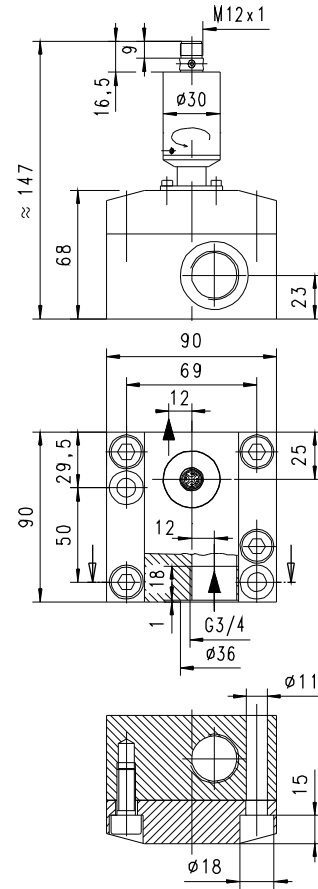

FLEX-VHZ-025

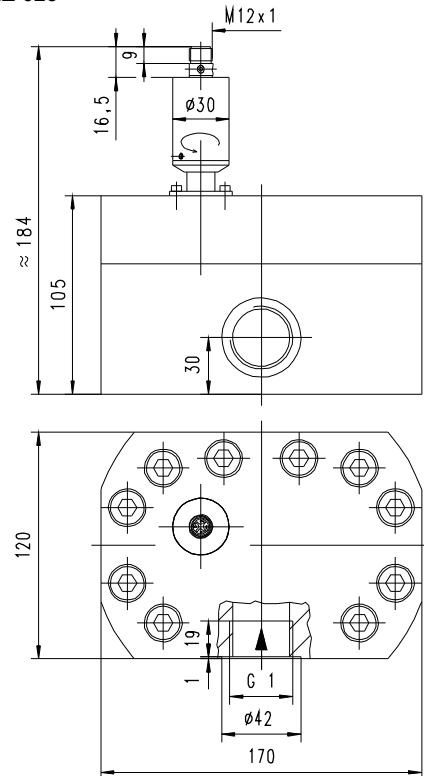

... professional Instruments "MADE IN GERMANY"

Produktinformation

Handling and operation

Installation

The VHZ flow measurement device can be installed anywhere in the pipework system. A run-in section is not required. The direction of flow may be freely chosen.

It should be ensured that no dirt particles (thread cutting swarf) can get into the flow space, as this could cause the blockage of the gearwheels. It may therefore be necessary to install filters upstream of the flow measurement device (mesh size 30 µm).

Programming

The electronics contain a magnetic contact, with the aid of which different parameters can be programmed. Programming takes place when a magnet clip is applied for a period between 0.5 and 2 seconds to the marking located on the label. If the contact time is longer or shorter than this, no programming takes place (protection against external magnetic fields).



After the programming ("teaching"), the clip can either be left on the device, or removed to protect data. The device has a yellow LED which flashes during the programming pulse. During operation, the LED serves as a status display for the switching output. In order to avoid the need to transit to an undesired operating status during "teaching", the device can be provided ex-works with a "teach-offset". The "teach-offset" value is added to the currently measured value before saving (or is subtracted if a negative value is entered).

Example: The switching value is to be set to 70 % of the metering range, because at this flow rate a critical process status is to be notified. However, only 50% can be achieved without danger. In this case, the device would be ordered with a "teach-offset" of +20 %. At 50 % in the process, a switching value of 70 % would then be stored during "teaching".

Normally, programming is used to set the limit switch. However, if desired, other parameters such as the end value of the analog or frequency output may also be set.

The limit switch can be used to monitor minimal or maximal.

With a minimum-switch, falling below the limit value causes a switchover to the alarm state. Return to the normal state occurs when the limit value plus the set hysteresis is again exceeded.

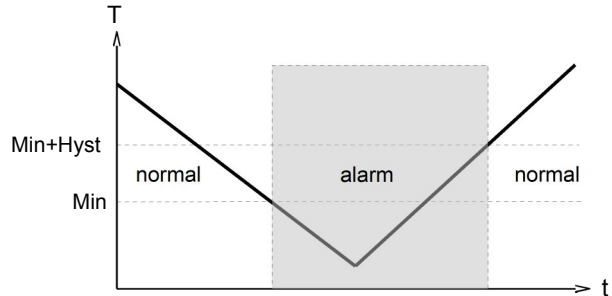

With a maximum-switch, exceeding the limit value causes a switchover to the alarm state. Return to the normal state occurs when the measured value once more falls below the limit value minus the set hysteresis.

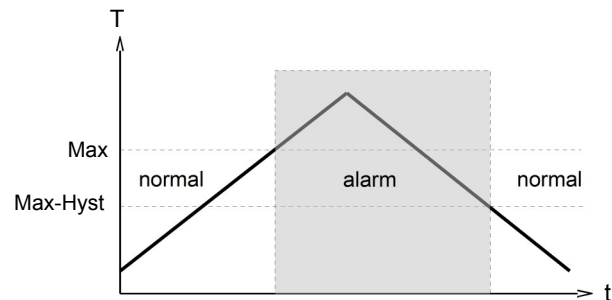

A switchover delay time (t_{DS}) can be applied to the switchover to the alarm state. Equally, one switch-back delay time (t_{DR}) of several can be applied to switching back to the normal state.

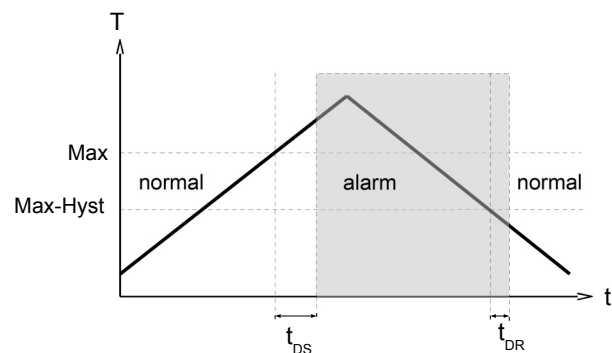

In the normal state the integrated LED is on, in the alarm state it is off, and this corresponds to its status when there is no supply voltage.

In the non-inverted (standard) model, while in the normal state the switching output is at the level of the supply voltage; in the alarm state it is at 0 V, so that a wire break would also display as an alarm state at the signal receiver. Optionally, an inverted switching output can also be provided, i.e. in the normal state the output is at 0 V, and in the alarm state it is at the level of the supply voltage.

Produktinformation

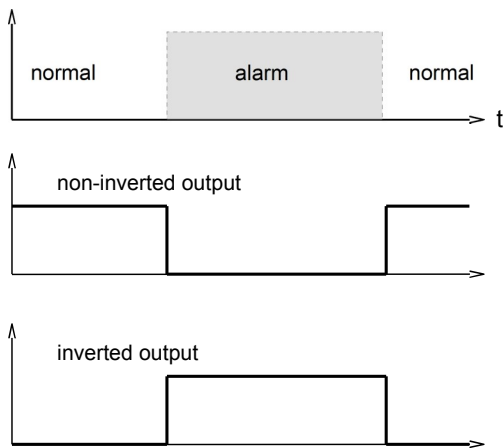

A Power-On delay function (ordered as a separate option) makes it possible to maintain the switching output in the normal state for a defined period after application of the supply voltage.

Ordering code

The base device is ordered, e.g. VHZ-008GA002E with electronics, e.g. FLEX-VHZ-008ILO

VHZ 1. 2. 3. 4. 5. 6.
 G **E**

FLEX-VHZ- 7. 8. 9. 10.

○=Option

1. Sight glass					
-	no sight glass				
O-	with sight glass				
2. Nominal width					
008	DN 8 - G 1/4				•
010	DN 10 - G 3/8				•
020	DN 20 - G 3/4				•
025	DN 25 - G 1				•
3. Process connection					
G	female thread				
4. Body material					
A	aluminium				•
K	○ stainless steel				•
5. Ranges					
002	0.02.. 2 l/min				•
006	0.10.. 6 l/min				•
050	0.50.. 50 l/min				•
150	3.00..150 l/min				•
6. Connection for					
E	electronics				•
7. For base device					
008	VHZ-008G...E				•
010	VHZ-010G...E				•
020	VHZ(O)-020G...E				•
025	VHZ-025G...E				•
8. Analog output					
I	current output 4..20 mA				
U	voltage output 0..10 V				

9. Functioning of the switching output	
L	minimum-switch
H	maximum-switch
R	frequency output
10. Switching signal	
O	standard output
I	inverted output

Options

Special range for analog output: l/min
 (not greater than the sensor's working range)

Special range for frequency output: l/min
 (not greater than the sensor's working range)

End frequency (max. 2000 Hz) Hz

Switch-on delay (from Alarm to OK) s

Switch-off-delay (from OK to Alarm) s

Power-On delay (0..99 s) s
 (time after power on, during which the outputs are not actuated)

Switching output fixed l/min

Special hysteresis (standard = 2 % EW) %

Gooseneck
 (recommended at operating temperatures above 70 °C)

If the fields are not completed, the standard setting is selected automatically.

Accessories

- Cable/round plug connector (KB...) see additional information "Accessories"
- Device configurator ECI-1