

Produktinformation

Flow Transmitter / Switch FLEX-CF

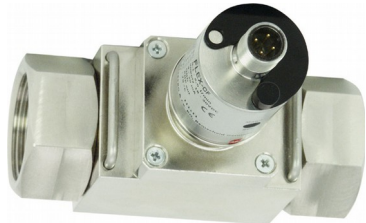

- Universal flow sensor with vortex working principle
- Switching output and analog output (4..20 mA / 0..10 V)
- Ingress protection IP 67
- Cable outlet infinitely rotatable
- Robust stainless steel housing

Characteristics

A narrow triangular body (1), which goes through the complete cross-section of the measurement pipe, creates vortices in the medium when there is a flow (Kármán vortex street, vortex effect). The frequency of the vortex is proportional to the flow, and is detected using a piezo-sensor (2), which lies behind the triangular body. The complete unit, vortex body, and detector are designed as a plug-in unit (3), and are inserted into the pipe. Here, a lightning fast separation between measurement pipe and the complete measurement unit is possible.

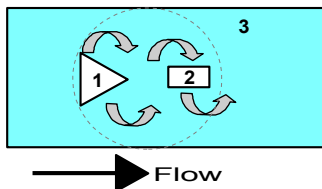

The FLEX transducer on the sensor has an analog output (4..20 mA or 0..10 V) and one switching output, which can be configured as a limit switch for monitoring minimal or maximal, or as a frequency output or pulse output. The switching output is designed as a push-pull driver, and can therefore be used both as a PNP or an NPN output. The state of the switching output is signalled with a yellow LED in the switching outlet; the LED has all-round visibility.

The sensor is configured in the factory, or alternatively this can be done with the aid of the optionally available ECI-1 device configurator (USB interface for PC). A selectable parameter can be modified on the device, with the aid of the magnet clip provided. In this case, the current measured value is saved as the parameter value. Examples of these parameters are the switching value or the fullscale value.

The stainless steel electronics housing is rotatable, so it is possible to orient the cable outlet after installation.

Technical data

Sensor	vortex principle	
Nominal width	DN 8..25	
Process connection	female thread G 1/4..G 1 (others available on request)	
Metering ranges	0.9..150 l/min for details, see table "Ranges"	
Measurement accuracy	up to 50 % of full scale value: ±1 % of measured value from 50 % of full scale value: ±2 % of measured value	
Pressure resistance	PN 10 bar	
Media temperature	0..60 °C	
Ambient temperature	-20..+70 °C	
Materials medium-contact	Housing	CW614N plated, 1.4571 or POM GF
	Connection	CW614N plated, 1.4571 or POM
	Detector	ETFE PA6T6I 40 % GF
	Seal	EPDM
Supply voltage	18..30 V DC	
Power consumption	<1 W	
Analog output	4..20 mA / load 500 Ohm max. or 0..10 V / load min. 1 kOhm	
Switching output	transistor output "push-pull" (resistant to short circuits and polarity reversal) $I_{out} = 100 \text{ mA max.}$	
Switching hysteresis	adjustable (please state when ordering) Standard setting: 2 % F.S., for Min-switch, position of the hysteresis above the limit value, and for Max-switch, below the limit value	
Pulse output	pulse width 50 ms → max. output frequency < 20 Hz	
Display	yellow LED (On = Normal / Off = Alarm)	
Electrical connection	for round plug connector M12x1, 4-pole	
Ingress protection	IP 67	
Weight	see table "Dimensions"	
Conformity	CE	

Produktinformation

Signal output curves

Value x = Begin of the specified range
 = not specified range

Current output

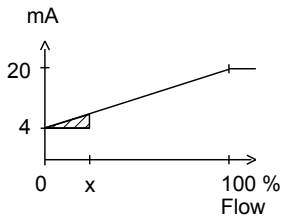

Voltage output

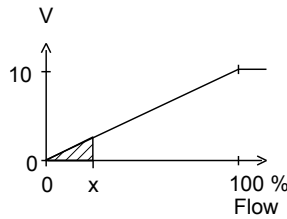

Frequency output

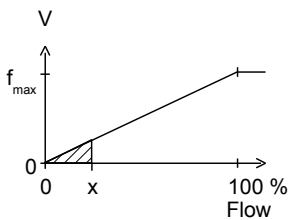

f_{max} selectable in the range of up to 2000 Hz

Other characters on request.

Ranges

G	Types	Range l/min H ₂ O
G 1/4	FLEX-CF-008	0.9.. 15 l/min
G 3/8	FLEX-CF-010	1.8.. 32 l/min
G 1/2	FLEX-CF-015	3.5.. 50 l/min
G 3/4	FLEX-CF-020	5.0.. 85 l/min
G 1	FLEX-CF-025	9.0..150 l/min

Wiring

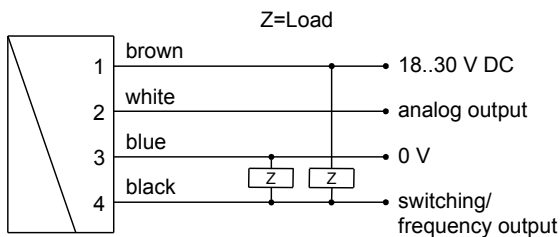

Connection example: PNP NPN

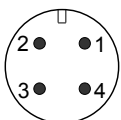

Before the electrical installation, it must be ensured that the supply voltage corresponds with the data sheet.
 It is recommended to use shielded wiring.

Dimensions

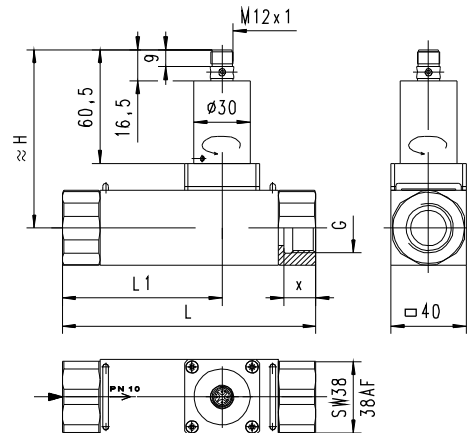

G	DN	Types	H	L	L1	X	Weight* kg
G 1/4	DN 8	FLEX-CF-008	93	125	69	12.5	2.23
G 3/8	DN 10	FLEX-CF-010	91	100	50		1.88
G 1/2	DN 15	FLEX-CF-015	93			14.5	1.88
G 3/4	DN 20	FLEX-CF-020	95	135	85	16.5	2.28
G 1	DN 25	FLEX-CF-025	97	155	95	18.5	2.08

*Weight details for metal model. Plastic models available on request

Handling and operation

Installation

The vortex flow meter requires a run-in length of 5..10 x D in order to achieve its specified accuracy. If deposits are to be expected, sensor and electronics should not be installed underneath. It should be ensured that the sensor is installed in the direction of the flow arrow. If the sensor is to be cleaned, the clamps should be released, and the device removed (the pipe should be pressure-free for this). It should be ensured during cleaning that the oscillating vortex body is not exposed to impact (in the moulded part there is a sensitive piezo-ceramic sensor, which can break). The electronics housing is permanently connected to the sensor, and cannot be removed by the user. After installation, the electronic head can be turned to align the cable outlet.

Programming

The electronics contain a magnetic contact, with the aid of which different parameters can be programmed. Programming takes place when a magnet clip is applied for a period between 0.5 and 2 seconds to the marking located on the label. If the contact time is longer or shorter than this, no programming takes place (protection against external magnetic fields).



After the programming ("teaching"), the clip can either be left on the device, or removed to protect data. The device has a yellow LED which flashes during the programming pulse. During operation, the LED serves as a status display for the switching output. In order to avoid the need to transit to an undesired operating

Produktinformation

status during "teaching", the device can be provided ex-works with a "teach-offset". The "teach-offset" value is added to the currently measured value before saving (or is subtracted if a negative value is entered).

Example: The switching value is to be set to 70 % of the metering range, because at this flow rate a critical process status is to be notified. However, only 50% can be achieved without danger. In this case, the device would be ordered with a "teach-offset" of +20 %. At 50 % in the process, a switching value of 70 % would then be stored during "teaching".

Normally, programming is used to set the limit switch. However, if desired, other parameters such as the end value of the analog or frequency output may also be set.

The limit switch can be used to monitor minimal or maximal.

With a minimum-switch, falling below the limit value causes a switchover to the alarm state. Return to the normal state occurs when the limit value plus the set hysteresis is again exceeded.

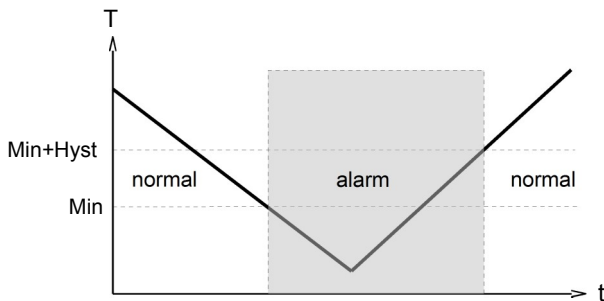

With a maximum-switch, exceeding the limit value causes a switchover to the alarm state. Return to the normal state occurs when the measured value once more falls below the limit value minus the set hysteresis.

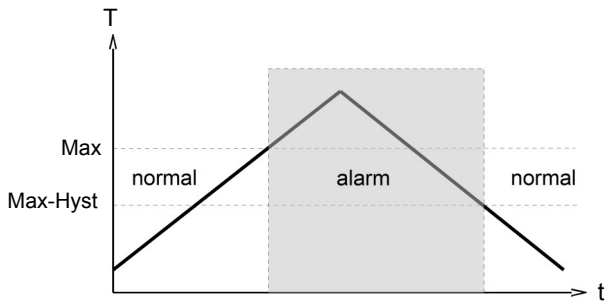

A switchover delay time (t_{DS}) can be applied to the switchover to the alarm state. Equally, one switch-back delay time (t_{DR}) of several can be applied to switching back to the normal state.

In the normal state the integrated LED is on, in the alarm state it is off, and this corresponds to its status when there is no supply voltage.

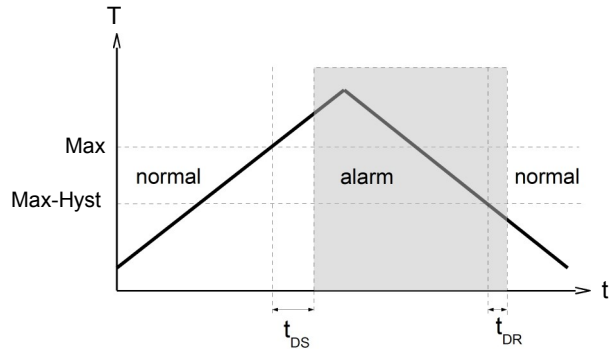

In the non-inverted (standard) model, while in the normal state the switching output is at the level of the supply voltage; in the alarm state it is at 0 V, so that a wire break would also display as an alarm state at the signal receiver. Optionally, an inverted switching output can also be provided, i.e. in the normal state the output is at 0 V, and in the alarm state it is at the level of the supply voltage.

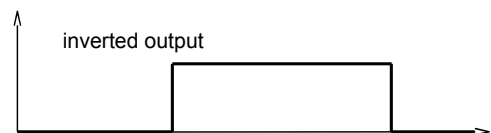
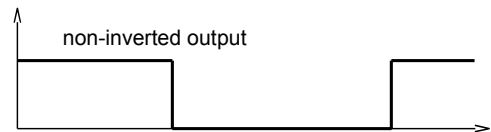
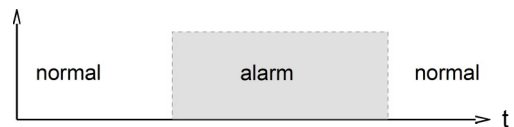

A Power-On delay function (ordered as a separate option) makes it possible to maintain the switching output in the normal state for a defined period after application of the supply voltage.

Produktinformation

Ordering code

The basic device is ordered e.g. CF-xxx
with electronics e.g. FLEX-CF-xxx

CF-

FLEX-CF-

○=Option

1. Nominal width							
008	DN 8 - G 1/4						
010	DN 10 - G 3/8						
015	DN 15 - G 1/2						
020	DN 20 - G 3/4						
025	DN 25 - G 1						
2. Process connection							
G	female thread						
3. Connection material							
M	CW614N plated						
K	○ 1.4571						
P	○ POM						
4. Body material							
M	CW614N plated						
K	1.4571						
P	○ POM GF						
5. Metering range							
015	0.9.. 15 l/min						●
032	1.8.. 32 l/min						●
050	3.5.. 50 l/min						●
085	5.0.. 85 l/min						●
150	9.0..150 l/min						●
6. Sealing material							
E	EPDM						
7. Connection for							
E	electronics						
8. For nominal width							
008	DN 8 - G 1/4						●
010	DN 10 - G 3/8						●
015	DN 15 - G 1/2						●
020	DN 20 - G 3/4						●
025	DN 25 - G 1						●
9. Analog output							
I	current output 4..20 mA						
U	voltage output 0..10 V						
10. Functioning of the switching output							
L	minimum switch						
H	○ maximum switch						
R	frequency output						
C	Pulse output						
11. Switching signal							
O	standard output						
I	inverted output						

Required ordering information

For FLEX-CF-C:

For the pulse output version, the volume (with numerical value and unit) which will correspond to one pulse must be stated.

Volume per pulse (numerical value)

Volume per pulse (unit)

Options

Special range for analog output: l/min
(not greater than the sensor's working range)

Special range for frequency output: l/min
(not greater than the sensor's working range)

End frequency (max. 2000 Hz) Hz

Switching delay (from Normal to Alarm) s

Switchback delay (from Alarm to Normal) s

Power-On delay (0..99 s) s
(time after power on, during which the outputs are not actuated)

Switching output fixed l/min

Special hysteresis (standard = 2 % EW) %

Accessories

- Cable/round plug connector (KB...) see additional information "Accessories"
- Device configurator ECI-1